



Body Worn Camera
USER MANUAL

Preface

Welcome to the world of Hytera and thank you for purchasing this product. To derive optimum performance from the product, please carefully read this manual before use.

This manual is applicable to the following product:

[VM780 4G Body Worn Camera \(MPU\)](#)

Copyright Information

Hytera is the trademark or registered trademark of Hytera Communications Corporation Limited (the Company) in the People's Republic of China (PRC) and/or other countries or areas. The Company retains the ownership of its trademarks and product names. All other trademarks and/or product names that may be used in this manual are properties of their respective owners.

The product described in this manual may include the Company's computer programs stored in memory or other media. Laws in PRC and/or other countries or areas protect the exclusive rights of the Company with respect to its computer programs. The purchase of this product shall not be deemed to grant, either directly or by implication, any rights to the purchaser regarding the Company's computer programs. The Company's computer programs may not be copied, modified, distributed, decompiled, or reverse-engineered in any manner without the prior written consent of the Company.

Disclaimer

The Company endeavors to achieve the accuracy and completeness of this manual, but no warranty of accuracy or reliability is given. All the specifications and designs are subject to change without notice due to continuous technological development. No part of this manual may be copied, modified, translated, or distributed in any manner without the prior written consent of the Company.

We do not guarantee, for any particular purpose, the accuracy, validity, timeliness, legitimacy or completeness of the third-party products and contents involved in this manual.

If you have any suggestions or would like to receive more information, please visit our website at: <http://www.hytera.com>.

FCC Statement

This equipment has been tested and found to comply with the limits for a Class B digital device, pursuant to part 15 of FCC Rules. These limits are designed to provide reasonable protection against harmful interference in a residential installation. This equipment generates and can radiate radio frequency energy. If not installed and used in accordance with the instructions, it may cause harmful interference to radio communications. However, there is no guarantee that interference will not occur in a particular installation. Verification of harmful interference by this equipment to radio or television reception can be determined by turning it off and then on. The user is encouraged to try to correct the interference by one or more of the following measures:

- Reorient or relocate the receiving antenna. Increase the separation between the equipment and receiver.
- Connect the equipment into an outlet on a different circuit to that of the receiver's outlet.
- Consult the dealer or an experienced radio/TV technician for help.

Operation is subject to the following two conditions:

- This device may not cause harmful interference.
- This device must accept any interference received, including interference that may cause undesired operation.

Note: Changes or modifications to this unit not expressly approved by the party responsible for compliance could void the user's authority to operate the equipment.

Compliance with RF Exposure Standards

The radio complies with the following RF energy exposure standards and guidelines:

- United States Federal Communications Commission, Code of Federal Regulations; 47 CFR § 1.1307, 1.1310 and 2.1093
- American National Standards Institute (ANSI)/Institute of Electrical and Electronic Engineers (IEEE) C95.1:2005; Canada RSS102 Issue 5 March 2015
- Institute of Electrical and Electronic Engineers (IEEE) C95.1:2005 Edition

Specific Absorption Rate (SAR) information

SAR tests are conducted using standard operating positions accepted by the FCC with the phone transmitting at its highest certified power level in all tested frequency bands, although the SAR is determined at the highest certified power level, the actual SAR level of the phone while operating can be well below the maximum value, in general, the closer you are to a wireless base station antenna, the lower the power output. Before a new product is available for sale to the public, it must be tested and certified to the FCC that it does not exceed the exposure limit established by the FCC. Tests for each phone are performed in positions and locations as required by the FCC. For body worn operation, this product has been tested and meets the FCC RF exposure guidelines when used with an accessory designated for this product.

And for face up, 25mm was used for test, this equipment should be installed and operated with minimum distance 25mm.

RF Exposure Compliance and Control Guidelines and Operating Instructions

To control your exposure and ensure compliance with the exposure limits, always adhere to the following procedures.

Guidelines:

- Do not remove the RF Exposure Label from the device.
- User awareness instructions should accompany device when transferred to other users.
- Do not use this device if the operational requirements described herein are not met.

Operating Instructions:

- Keep the radio unit at least 2.5 cm away from the face. Keeping the radio at the proper distance is important as RF exposure decreases with distance from the antenna. The antenna should be kept away from the face and eyes
- When worn on the body, always place the radio in a Hytera-approved holder, holster, case, or body harness or by use of the correct clip for this product. Use of non-approved accessories may result in exposure levels which exceed the FCC's RF exposure limits.
- Use of non-approved antennas, batteries, and accessories causes the radio to exceed the FCC RF exposure guidelines.
- Contact your local dealer for the optional accessories of the product.

ISED Statement

The device has been tested and complies with SAR limits, users can obtain Canadian information on RF exposure and compliance

Après examen de ce matériel aux conformités aux limites DAS et/ou aux limites d'intensité de champ RF, les utilisateurs peuvent sur l'exposition aux radiofréquences et la conformité and compliance d'acquérir les informations correspondantes

This device complies with Innovation, Science and Economic Development Canada Compliance license-exempt RSS standard(s). Operation is subject to the following two conditions:

- This device may not cause harmful interference.
- This device must accept any interference received, including interference that may cause undesired operation.

Le présent appareil est conforme aux CNR d'Industrie Canada applicables aux appareils radio exempts de licence. L'exploitation est autorisée aux deux conditions suivantes: (1) l'appareil ne doit pas produire de brouillage, et (2) l'utilisateur de l'appareil doit accepter tout brouillage radioélectrique subi, même si le brouillage est susceptible d'en compromettre le fonctionnement

Under Innovation, Science and Economic Development Canada regulations, this radio transmitter may only operate using an antenna of a type and maximum (or lesser) gain approved for the transmitter by Industry Canada. To reduce potential radio interference to other users, the antenna type and its gain should be so chosen that, the equivalent isotropically radiated power (e.i.r.p.) is not more than that necessary for successful communication.

Conformément à la réglementation d'Innovation, la science et le développement économique Canada, le présent émetteur radio peut fonctionner avec une antenne d'un type et d'un gain maximal (ou inférieur) approuvé pour l'émetteur par Industrie Canada. Dans le but de réduire les risques de brouillage radioélectrique à l'intention des autres utilisateurs, il faut choisir le type d'antenne et son gain de sorte que la puissance isotrope rayonnée équivalente (p.i.r.e.) ne dépasse pas l'intensité nécessaire à l'établissement d'une communication satisfaisante.

EU Regulatory Conformance

As certified by the qualified laboratory, the product is in compliance with the essential requirements and other relevant provisions of 2014/53/EU.

Please note that the above information is applicable to EU countries only.

Icon Conventions

The following icons are available through this manual:



Note: Indicates references that can further describe the related topics.



Caution: Indicates situations that could cause data loss or equipment damage.

Key Operation

Long press: To keep pressing a key for two seconds.

Press: To press a key and release it immediately.

Press and hold: To press a key and keep holding it down.

Copyright Information

Hytera is the trademark or registered trademark of Hytera Communications Corporation Limited (the Company) in PRC and/or other countries or areas. The Company retains the ownership of its trademarks and product names. All other trademarks and/or product names that may be used in this manual are properties of their respective owners.

The product described in this manual may include the Company's computer programs stored in memory or other media. Laws in PRC and/or other countries or areas protect the exclusive rights of the Company with respect to its computer programs. The purchase of this product shall not be deemed to grant, either directly or by implication, any rights to the purchaser regarding the Company's computer programs. The Company's computer programs may not be copied, modified, distributed, decompiled, or reverse-engineered in any manner without the prior written consent of the Company.

Disclaimer

The Company endeavors to achieve the accuracy and completeness of this manual, but no warranty of accuracy or reliability is given. All the specifications and designs are subject to change without notice due to continuous technological development. No part of this manual may be copied, modified, translated, or distributed in any manner without the prior written consent of the Company.

We do not guarantee, for any particular purpose, the accuracy, validity, timeliness, legitimacy or completeness of the third-party products and contents involved in this manual.

If you have any suggestions or would like to receive more information, please visit our website at:

<http://www.hytera.com>.

EU Regulatory Conformance

As certified by the qualified laboratory, the product is in compliance with the essential requirements and other relevant provisions of the following directives:

- 2006/66/EC
- 2011/65/EU
- 2012/19/EU
- 2014/53/EU

Please note that the above information is applicable to EU countries only.

1. Packing List

Please unpack carefully and check that all items listed below are received. If any item is missing or damaged, please contact your dealer.

Item	Qty.	Item	Qty.
Body Worn Camera	1	USB Cable	1
Battery	1	Power Adapter	1
Belt Clip	1	User Manual	1

 Note

Pictures listed in this manual are for reference only.

2. Product Overview

2.1 Product Layout

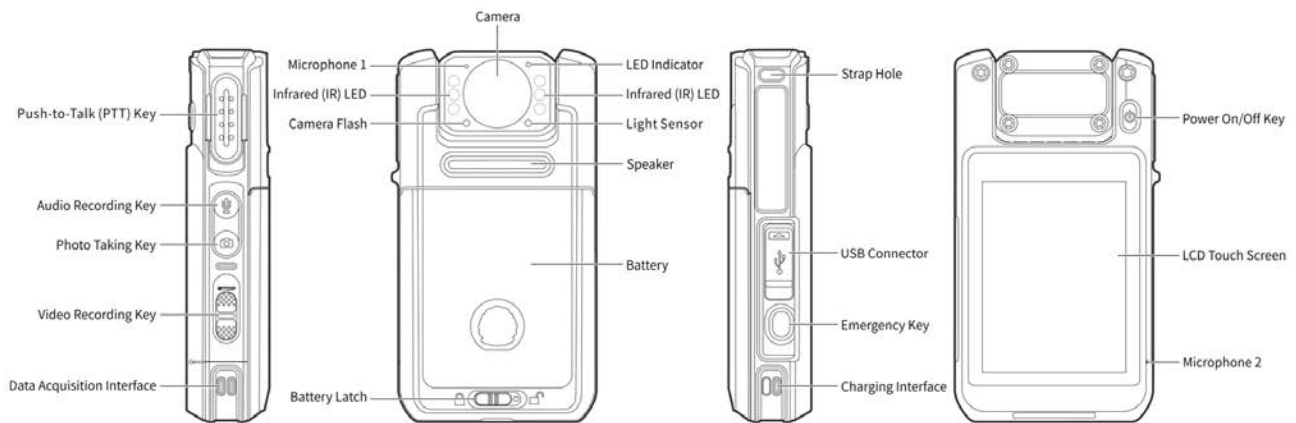

2.2 LED Indicators

Status	Description
Glows red	<ul style="list-style-type: none"> ● The product is transmitting voice or emergency alarm. ● The product is being charged. ● The TF card is full (lasts for three seconds). ● The product is being turned off (lasts for two seconds).
Glows green	<ul style="list-style-type: none"> ● The product is receiving voice or emergency alarm. ● The product is fully charged. ● The product is being turned on.
Glows orange	Call hang time. You can press and hold the PTT key to speak.
Flashes orange rapidly	<ul style="list-style-type: none"> ● No voice transmission in emergency mode. ● The remaining capacity of the TF card is less than 2 GB (lasts for three seconds).
Flashes red slowly	<ul style="list-style-type: none"> ● Flashes once every second: The product is recording a video. ● Flashes once every five seconds: The battery runs low. Please recharge or replace the battery in time.

Status	Description
Flashes orange slowly	The product is recording an audio.

3. Before Use

3.1 Installing the Nano SIM Card

Open the card slot cover and unlock the SIM card flip cover according to the instructions on it. Place the Nano SIM card into the slot and lock the flip cover and slot cover, as shown in the following figure.

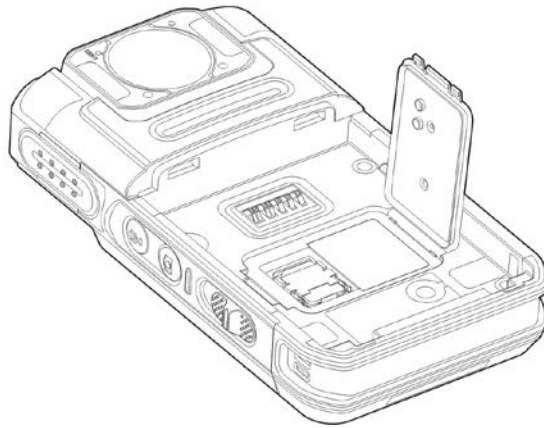

3.2 Attaching the Battery

⚠ Caution

- Use only the Hytera standard or optional battery. Polarity reverse or use of other batteries may result in explosion and fire hazards.
- Dispose of used batteries in accordance with the "Recycling and Handling Safety Precautions" in the *Safety Information Manual*.

Attach the battery according to the steps shown in the following figure. To remove the battery, turn off the product and reverse the attaching steps.



3.3 Attaching the Belt Clip

Attach the belt clip according to the steps shown in the following figure. To remove the belt clip, reverse the attaching steps.

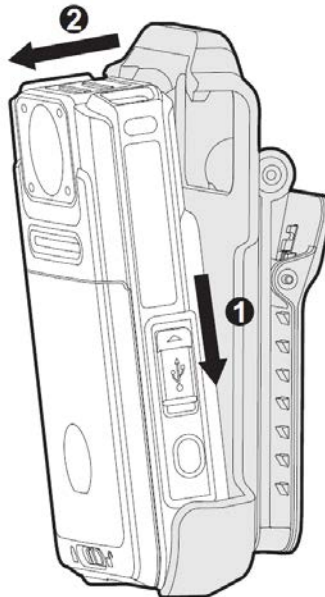

3.4 Charging the Product

To charge the product, do as follows:

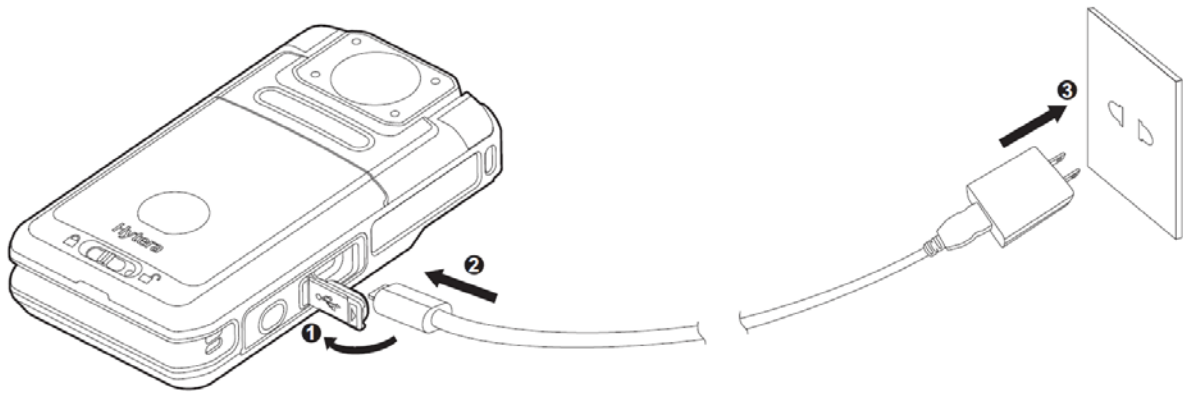

The LED indicator on the product tells its charging status, see **2.2 LED Indicators** for details.

4. Basic Operations

4.1 Turning On or Off the Product

Turning On the Product

In power-off mode, long press the **On/Off** key for three seconds to turn on the product and enter the preview mode.

Turning Off the Product

In power-on mode, long press the **On/Off** key for three seconds to turn off the product.



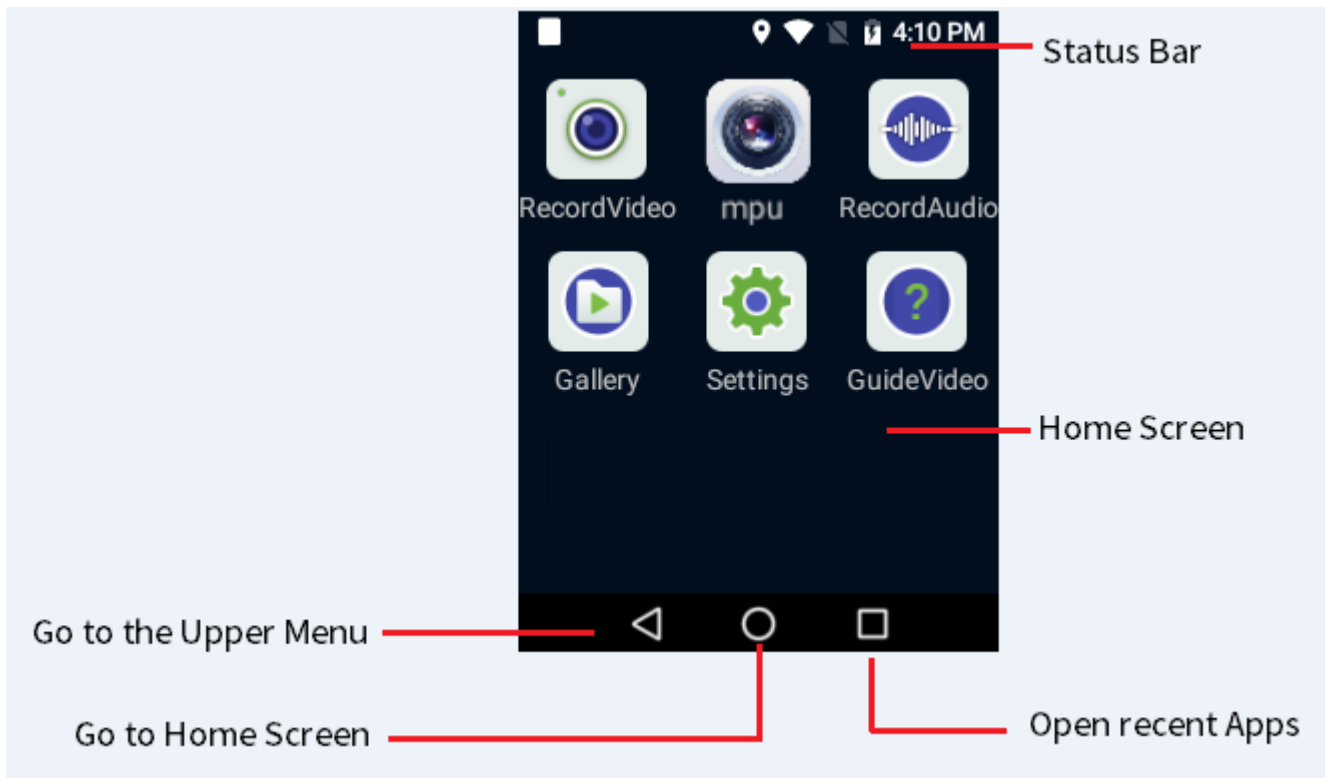







4.2 Understanding the Screen



4.2.1 Status Display

The status bar displays the notifications and running status of the product in real-time. Common status icons are described in the following table.

Icon	Meaning	Icon	Meaning
------	---------	------	---------

Icon	Meaning	Icon	Meaning
	Airplane mode is enabled.		WLAN connection is established.
	Location information is enabled.		Cellular network is enabled.
	BT feature is enabled.		No SIM card is inserted.
	BT connection is established.		The battery power is full.
	Silent mode is enabled.		The battery is being charged.

4.2.2 Notifications and Shortcuts

New notifications display shortly on the top of screen, or display constantly in the middle of screen till you acknowledge it.

On the main screen, swipe down from the status bar to open the notification center, where you can adjust brightness, turn on or turn off shortcut switches, open settings, and view or clear notifications.

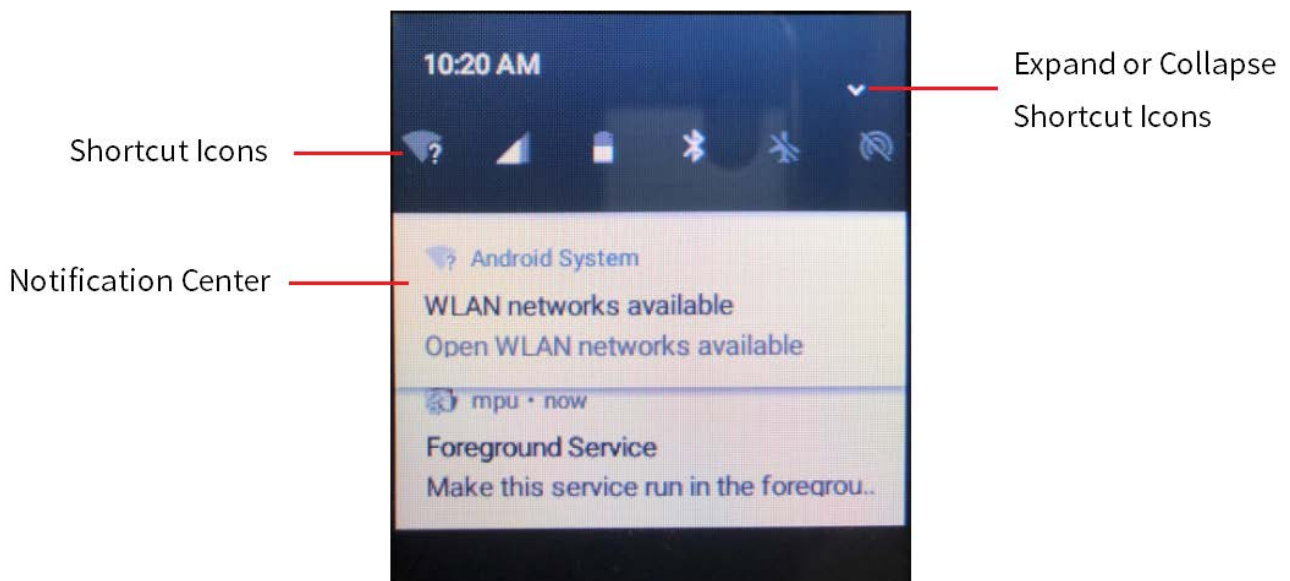

4.2.3 Sleep and Wakeup

Sleep

In power-on mode, press the **On/Off** key to enter sleep mode. You can also set the sleep time in **Settings > System Settings**; when the sleep time is up, the product enters sleep mode automatically.



Wakeup

When the screen goes off, press any key to wake up the screen.

4.3 Connecting to Network

4.3.1 Cellular Data





Before enabling the cellular network, make sure that the SIM card has been registered to the Carrier Networks. When not used, disable the cellular network to save traffic and extend the standby time.

1. Wipe down from the status bar to open the notification center, and tap .
2. Tap  to enable the cellular network; or tap  to disable the cellular network.

4.3.2 WLAN

Connect to a WLAN (Wireless Local Area Networks) to visit the Internet or shared files from other network devices.

To use the WLAN, do one of the following:

- Enable WLAN through the shortcut switch.
 - a) Swipe down from the status bar to display all shortcut switches. Tap  to enable WLAN.
 - b) Select available network from the WLAN list.
 - c) (Optional) If the network displays with a  icon, enter the password and tap **Connect**.
- Enable WLAN through **Settings**.
 - a) Tap  on the home screen, and tap **WLAN** to enable WLAN.
 - b) Select available network from the WLAN list.
 - c) (Optional) If the network displays with a  icon, enter the password and tap **Connect**.

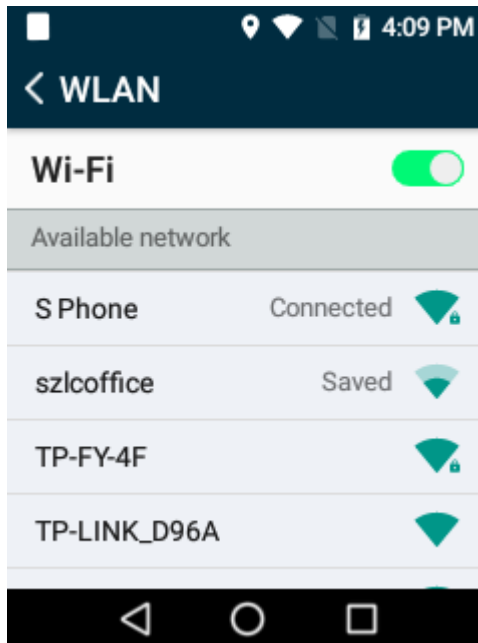

The product automatically saves WLAN information upon successful connection, and automatically connects to the network when WLAN is switched on.

4.4 Authentication

The product requires authentication upon first time of use. The procedure of authentication is as follows.

1. Obtain the authentication code from Hytera.
2. In the MPU video preview screen, tap  and select **Auth**.
3. In the Auth page, enter the authentication code and tap **Save**.
4. In the blank space of the authentication page, tap the screen for six times to display the **Auth_ID** information.
5. Tap **Get Auth_ID**, and send the ID to Hytera.

After the authentication is completed, the screen displays with **Registered**. Exit MPU and open it again.

4.5 Logging in to the SmartEye Server

You need to log in to the SmartEye Server to use features such as video polling, voice communication and remote photo capture.

1. In the MPU preview screen, tap  and select **Login**.
2. In the login page, enter the server address and port number (default: 9702) of the SmartEye server, and tap **OK** and log in.

Upon successful login, the **Login** button turns into **Logout**.

5. System Settings

Tap  on the home screen, and enter the **Settings**. You can set the network, display, voice, BT, language, location information, and silent mode, and view the account information and product information.

5.1 Network

5.1.1 Data Roaming

Tap **SIM Card Settings**, and toggle  to enable data roaming.

5.1.2 Airplane Mode

To avoid signal interferences while you are on a plane, please turn off the product or turn on the airplane mode. In airplane mode, the product disables data or WLAN network, and you cannot use the voice, video and data services. If the airline company permits, you can manually enable BT or WLAN feature.

Tap **System Settings**, and toggle the  following the airplane mode to enable it.

Note

You can also enable or disable the airplane mode by tapping the  icon in the shortcut switches.

5.2 Display

5.2.1 Brightness

Manual Adjustment

Tap **System Settings**, and drag the slide block in the **Display Settings** to adjust screen brightness.

Note

You can also adjust brightness by dragging the slide block for brightness in the drop-down status bar.

Adaptive Brightness

Tap **System Settings**, and toggle the  following the **Adaptive Brightness**.

5.2.2 Sleep

This feature allows the product to enter sleep mode for saving battery power, if no operation is made within predefined time.

To set the sleep time, tap **System Settings**, and tap **Sleep**.

The sleep time options include Never, 10s, 20s and 30s.

5.3 Sound

5.3.1 Volume Adjustment

Tap **System Settings**, and drag the slide blocks following media volume, alarm volume, and call volume in the **Sound Settings** to adjust volume.

5.3.2 Ring/Silent Mode

The product is set to ring mode by default. You can set the silent mode according to actual needs.

Ring Mode

- Tap **System Settings**, and toggle the  following the **Silent Mode** to enable ring mode.

Silent Mode

Tap **System Settings**, and toggle the  following the **Silent Mode** to enable silent mode.

5.4 BT

You can pair the product with other BT devices to transfer data through BT feature.

1. Tap **BT**, and toggle the  following **BT** to enable it.
2. Tap a device in the device list, and tap **Pair** in the popup pair request window.

Note

- If this product needs to be detected by other BT devices, toggle  following VM780.
-

-
- Other matching methods: slide down the status bar to expand all shortcut switches, and tap . Tap **More Settings**, select a device in the device list, and then tap **Pair** in the popup pair request window.
-

5.5 Language

Tap **Language**, and select from the language list.



5.6 Location

After enabling the location information, the product obtains location information through GPS, WLAN, BT or cellular network.

1. Tap **Location**, and tap the  following **Location** to enable it.
2. Tap **Mode** to set the mode of location information.
 - High Accuracy: Use GPS, WLAN, BT and cellular network to determine location.
 - Battery saving: Use WLAN, BT and cellular network to determine location.
 - Device only: Use GPS to determine location.

5.7 Date & Time

After connected to the network, the product can synchronize the date, time, time zone and time format of the system automatically via the network.

- Tap **Date & time**, and tap the  following **Automatic time zone**, the product will use the time zone provided by the network.
- Tap **Date & time**, and tap the  following **24-hour format**, the product will use the 24-hour time format.

5.8 Silent Mode

In silent mode, the product gives no alarms or rings; its indicators and screen goes dim to keep the product concealment.

Tap **Silent Mode**, and toggle the  following **Silent Mode** to enable it.

5.9 Accounts

Tap **Accounts** to view information such as user name, user number, unit name and unit number.

5.10 About Device

Tap **About Device** to view information such as software version, device name, device ID, serial number, storage capacity and available space.

6. MPU Basic Settings



In the MPU video preview mode, tap  and select **Settings**.

6.1 Language

1. Tap **Language** to enter the language setting page.
2. Select the desired language and tap **OK**.

Restart the MPU to validate the language setting.

6.2 Device Info

1. Tap **Device Info** to enter the device information page.
2. View the device ID and device name information, or tap them to edit.
3. (Optional) To obtain device ID from the SmartEye server automatically, toggle  to .

6.3 Storage

You can set storage information such as extended recorded time length, pre-recording time length, video time length, video (audio) file name format and photo custom name.

1. Tap **Storage** to enter the storage information page.
2. Set the parameters according to actual needs.

6.4 Infrared Settings

With infrared turned on, when the product is recording video in dark environment, it automatically turns on the IR LED.

Tap **Infrared Settings** and select AUTO, Open or Close.

6.5 Voice Settings

The product can give voice and speech reminders at certain operations. You can set this feature according to actual needs.

Tap **Voice Settings** and select Voice or Speech.

6.6 Version

You can view and update the current software version.

Viewing the Software Version

Tap **Version** and view the version code and version name.



Updating the Software Version

1. Tap **Version** and enter the version page.
2. Tap **Online Update** or **Local Update** to update the software version.

6.7 Platform



6.7.1 Auto Upload Photos

By enabling the Auto Upload Photos feature, photos are automatically uploaded to the SmartEye Server.



1. Tap **Platform** and enter the platform page.
2. Tap the  following Auto Upload Photos.
 - : The feature is disabled.
 - : The feature is enabled.

6.7.2 Automatic Upload of Key Videos

By enabling the Automatic Upload of Key Videos feature, photos are automatically uploaded to the SmartEye Server.



1. Tap **Platform** and enter the platform page.
2. Tap the  following Automatic Upload of Key Videos.
 - : The feature is disabled.
 - : The feature is enabled.

6.7.3 PTT Half Duplex Interconnection

1. Tap **Platform** and enter the platform page.
2. Tap the  following PTT Half Duplex Interconnection.
 - : The feature is disabled.

- : The feature is enabled.

6.7.4 GPS Storage

1. Tap **Platform** and enter the platform page.
2. Tap the  following GPS Storage.
 - : The feature is disabled.
 - : The feature is enabled.

6.8 Restore Default Settings

Tap **Restore Default Settings** and tap **OK** in the popup window to restore the MPU to factory settings.



Caution

Please choose carefully. After this operation, the current settings will be lost.

6.9 Screen Lit

By enabling Screen Lit, while the MPU is opened, the screen will always light up.



Tap the  following Screen Lit.

- : The feature is disabled.
- : The feature is enabled.

6.10 Auto Run and Auto Login

By enabling Auto Run, the product automatically opens MPU upon powering-on. By enabling Auto Login, the MPU automatically logs in to the SmartEye server upon MPU opening.



Tap the  following Auto Run or Auto Login.

- : The feature is disabled.
- : The feature is enabled.

6.11 GPS

By enabling GPS, the product automatically locates the current location.



Tap the  following GPS.

- : The feature is disabled.
- : The feature is enabled.

6.12 Auto Record

By enabling Auto Record, the product automatically records video upon powering-on.



Tap the  following Auto Record.

- : The feature is disabled.
- : The feature is enabled.

6.13 Circulating Storage

By enabling Circulating Storage, when the TF card is full in storage and a new video is being recorded, the product automatically deletes the oldest non-key video to store the new video.

Tap the  following Circulating Storage.



- : The feature is disabled.
- : The feature is enabled.

6.14 Pre-record and Post-record

The product is capable of pre- and post-recording to ensure all interactions during an incident are captured. Pre-recording allows officers to capture a period time of footage prior to an event that led them to press the record button, while post- recording can add a period time of footage after the recording is deactivated.

You can program the pre- and post- recording time length. See **6.3 Storage**.

Tap the  following Pre-record or Post-rec.

- : The feature is disabled.
- : The feature is enabled.

Note

You can also enable or disable pre-recording by long pressing the **Photo Taking** key.

7. MPU Other Settings

7.1 Camera Settings

You can set the camera shooting angle by adjusting the camera rotation.

1. In the MPU video preview mode, tap  to enter Camera.
2. Tap **Camera Rotation** to set the camera rotation degree, and tap **OK**. Check whether the camera picture is adjusted.

7.2 Video Settings

You can set the resolution, bitrate, frame, contrast, saturation and video encoder of the video. The video settings must be operated in logout status.

1. In the MPU video preview mode, tap  to enter Camera.
2. Tap **Video Settings** to set the parameters.

7.3 Audio Settings

You can set the audio encoder, channel number, bitrate, AEC parameters, and AGC parameters of the audio. The video settings must be operated in logout status.

1. In the MPU video preview mode, tap  and enter Camera.
2. Tap **Audio Settings** to set the parameters.
3. (Optional) To eliminate the echo between the product and SmartEye client, check **Enable**.

It is recommended to use microphone or earphone at the SmartEye client and BT earphone for this product to avoid echo.

7.4 OSD Information

You can add OSD type, OSD information, OSD render, OSD position and Custom Text to your videos or photos.

1. In the MPU video preview mode, tap  to enter Camera.
2. Tap **OSD Information** to set the parameters.
3. To validate the settings, check **Enable**.

8. MPU Features

8.1 Adjusting the Focus

You can adjust the camera focus up to 4 times zooming.

In the MPU video preview mode, drag the  icon to adjust the digital focus.

8.2 Recording Videos

- Normal recording: in preview mode, toggle the **Video Recording** key to start video recording; the LCD screen displays the recording time. During video recording, toggle the **Video Recording** key again to finish recording.
- Key recording: during video recording, press the **Audio Recording** key to mark the video as key recording or unmark a key recording.

8.3 Recording Audios

- Normal recording: in preview mode, long press the **Audio Recording** key to start audio recording; the LCD screen displays the recording time. During audio recording, long press the **Audio Recording** key again to finish recording.
- Key recording: during audio recording, press the **Audio Recording** key to mark the audio as key recording or unmark a key recording.

8.4 Taking Photos

Press the **Photo Taking** key to take a photo.

8.5 Taking Photos during Video Recording



During video recording, press the **Photo Taking** key to take a photo.

8.6 Uploading Files

1. In the MPU video preview mode, tap , and select **File Upload**.
2. Tap the desired tabs from **Photo Sync**, **Video Sync**, **Audio Sync** or **GPS Sync**, and check the files to be uploaded.

3. Tap  to upload the checked files to the SmartEye server.

8.7 Flashlight

In the MPU video preview mode, tap  icon to enable flashlight; tap the  icon to disable it.



Note

You can also enable or disable flashlight from the shortcut switch  in the status bar.

8.8 PoC Talking

1. In the MPU video preview mode, tap  and select **Chat**.
2. Select **Conversation > Meeting** and select meeting from the list.
3. Press and hold the **PTT** key to talk through the microphone; release the **PTT** key when you finish.

8.9 Emergency Mode

Enabling Emergency Mode

In emergency situations, press the **Emergency** key to enable emergency alarm. The product will start key video recording, enable video polling to the SmartEye client and seek help from the call taking and handling staff in the SmartEye.

Disabling Emergency Mode

In emergency mode, long press the **Emergency** key to disable emergency alarm. The product will finish key video recording and stop video polling to the SmartEye client.

8.10 Device Location

1. In the MPU video preview mode, tap , and select **Location**.
2. View the detailed location of the product on the map.

9. Playing Back Videos/Audios/Photos

1. Tap  in the home screen; enter the password (123456 as initial password) and tap **OK**.
-

Note

You can modify the password in the login interface.

2. Tap **Video**, **Audio** or **Picture** to enter the playback list of corresponding media.
3. Tap the video, audio or photo to play back

10. Data Acquisition

You can set the product into disk mode through the BWC Manager, and copy photos, audios and videos to your PC. For details on the operations, refer to the *BWC Manager Operation Guide* in the BWC Manager folder.

To connect the product with your PC, do as follows:

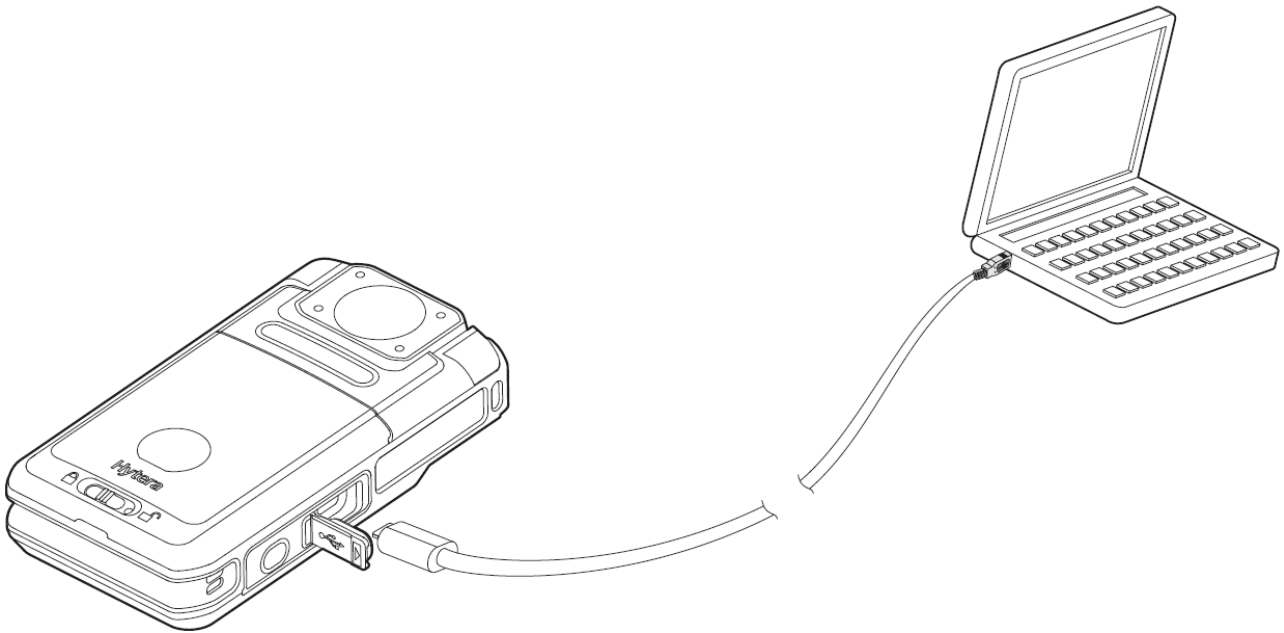

If you have purchased the multi-unit charger, you can also perform data acquisition through the charger. For details, refer to the related user manual.

11. Troubleshooting

Phenomena	Analysis	Solution
The product cannot be turned on	The battery may be improperly attached.	Remove the battery and attach it again.
	The battery may run out.	Recharge or replace the battery.
	The battery and the charging probes are in poor contact due to dirtied or damaged battery contacts.	Clean the battery contacts.
The volume is low when playing back audios or videos	The microphone and the speaker are blocked or damaged.	Clean the microphone and the speaker.
The product cannot record video or audio.	The TF card is full.	Switch to disk mode, and delete all data from the TF card after exporting them.
The product cannot take photo.		
The product cannot pre-record or extend-record the video.	The pre- or extend-recording feature is not enabled.	Enable the feature.
The product does not turn on the IR LED automatically when recording video in dark environment.	The IR LED feature is not enabled.	Enable the IR LED feature.
The product gives no alert tone; the indicator does not light up.	The Silent Mode is enabled.	Disable the Silent Mode.
The product gives no response to operations.	The product has crashed.	Press the Power On/Off key for 10 seconds to forcibly turn the product

Phenomena	Analysis	Solution
		off.

If the above solutions cannot solve your problems, or you may have some other queries, please contact us or your local dealer for more technical support.

12. Care and Cleaning

To guarantee optimum performance as well as a long service life of the product, please follow the tips below.

Product Care

- Do not pierce or scrape the product.
- Keep the product away from substances that can corrode the circuitry.
- Do not hold the product by the connection cable.
- Attach the USB port cover when the USB port is not in use.

Product Cleaning

Caution

- Power off the product before cleaning.
 - Make sure the product is completely dry before use.
-

- Clean up the dust and fine particles on the product's surface with a clean and dry lint-free cloth or a brush regularly.
- Use neutral cleanser and a non-woven fabric to clean the keys and surface after long-time use. Do not use chemical preparations such as stain removers, alcohol, sprays or oil preparations, so as to avoid surface damage.

13. Optional Accessories

 Caution

Use the accessories specified by the Company only; otherwise, we shall not be liable for any losses or damages arising out of the use of any unauthorized accessories.

Contact your local dealer for the optional accessories of the product.



is the trademark or registered trademark of Hytera Communications Corporation Limited. ©2019 Hytera Communications Corporation Limited. All Rights Reserved.

Address: Hytera Tower, Hi-Tech Industrial Park North, 9108# Beihuan Road, Nanshan District, Shenzhen, People's Republic of China

Postcode: 518057

[http:// www.hytera.com](http://www.hytera.com)